

## FiberLite FRP™ panels

Rev. 08 9/15

### Please Read Disclaimers:

#### PLEASE READ ALL INSTRUCTIONS BEFORE BEGINNING INSTALLATION!!

These guidelines are provided in good faith to help prevent any problems caused by common errors in installation. The manufacturer and/or distributor of this product shall not be held responsible for installation actions taken or not taken. There are many details of installation that are assumed to be general construction knowledge to experienced installers; which are not included in these instructions. These installation guidelines are intended to be strictly recommendations and are NOT to serve as a step-by-step, fail-safe installation checklist. Conditions of use are beyond our control and all risks are assumed by the user. Selection of an experienced installer is the sole responsibility of the project owner and architect.

Nudo Products, Inc. does not accept any responsibility for job failure resulting from or associated with improper site environmental conditions.

#### Uses & Applications:

FiberLite FRP panels (without pre-laminated substrate) should only be installed over a solid wall surfaces (wood, drywall, etc.) It should NOT be applied directly to wood or metal studs. Wall surfaces should be clean, flat, dry and smooth. Uneven wall surfaces should be corrected for best results. FiberLite FRP may form and contour to wall surface that are not prepared prior to installation. Following adhesive manufacturers' application guidelines when choosing proper adhesives for the particular substrate you are bonding to is highly recommended.

FiberLite FRP panels may also be used as drop in ceiling panels. Clips are recommended to hold panels in place.

Note: Due to the nature of Fiberglass Reinforced Plastic (FRP) panels may have moderate bowing prior to installation. All FiberLite FRP are USDA accepted.

#### Safety Instructions:

When cutting or drilling, always wear protective glasses or goggles and a face mask which covers the face and mouth. Itching due to fibers may be avoided by the use of barrier creams on exposed skin areas.

#### Tools Needed

#### Materials Needed

- Power saws with carbide tipped saw blades
- Power drill with carbide bits
- Pencil
- FiberLite FRP panels
- Adhesive manufacturer's recommended adhesive and trowel
- Rags and non-abrasive cleaner, soap and water, mineral spirits, for use in clean-up
- Personal protection equipment (goggles & mask)
- Tape measure
- Saw horses
- Painter's tape
- Plywood larger than panels
- Ladders or scaffolding

**Storage and Preparation**

All FiberLite FRP panels should be stored indoors in a dry area. Do not store panels outdoors. Panels should be unwrapped and removed from skid and stacked on a flat, dry surface. Do not stand panels on edge or stack on fresh concrete floor or any other surface that emits moisture. Panel should be acclimated to temperature and humidity of space for at least 24 hours prior to installation. Ideally, the room temperature and humidity during acclimation and installation should be the same as the final operation conditions. Optimum storage conditions are 60°F (16°C) to 75°F (24°C) and 35% to 55% relative humidity.

**Expansion & Contraction**

FiberLite FRP panels will expand and contract. When using mechanical fasteners, pre-drill holes slightly larger than diameter of fastener shank to allow for normal expansion and contraction. Always allow 1/8" gap at ceiling, base and gap between panels. If face mounted moldings (T-Bar, Batten, 2-Piece Division bar, etc...) allow 1/8" gap between panels (see diagram). Allow more space for expansion and contraction of panels longer than 8' and in area(s) where high fluctuation in temperature and humidity occur and when installing around pipes, conduits, electrical outlets, etc.

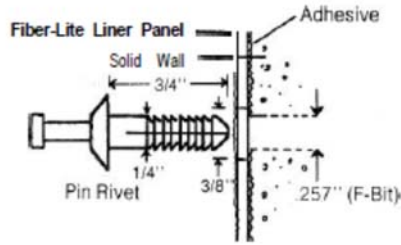
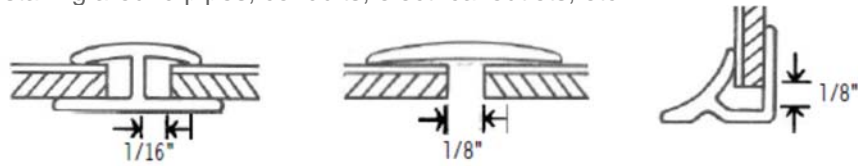

Note: Allow for expansion of panels when installing around pipes, conduits, electrical outlets, etc.

**Molding & Sealants**

Use of moldings and silicone sealant with panels is recommended to achieve a moisture resistant installation. Cut molding to size and place silicone sealant into channel of molding during installation. Place molding on panel before fastening and place small amount of silicone into hold before fastening. (Typical vinyl molding used with .090 FiberLite FRP V-1, V-3, V-5 and V-7. Please refer to accessory brochure for additional moldings available.)

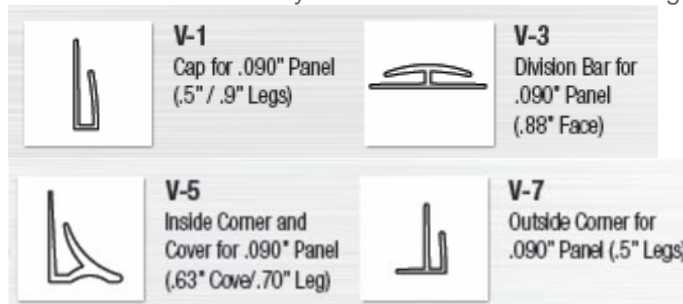

## Adhesive



You should always apply 100% adhesive coverage to back of panel when installing Fiber-Lite FRP panels. Titebond adhesives are recommended. Refer to adhesive manufacturers guidelines for adhesive acceptable for use on drywall, plywood, OSB and gypsum walls, etc. Adhesive failure is not panel failure.



Example of properly troweled adhesive application

## Fasteners

If using fasteners in combination with adhesive in high moisture areas, the use of non-corroding fasteners such as plastic pin rivets, chrome pin rivets, one piece nylon rivets, one stepper fasteners or screws should be considered. When installing with fasteners, always select proper size, they should be fit snug, but should not be over-tightened. Fasteners holes should be slightly oversized to allow for expansion and contraction.

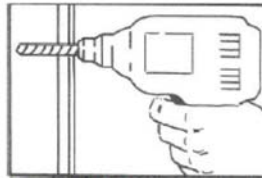

Easy to use Drill a hole (.257"-F Bit)

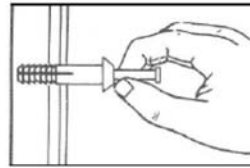

Remove dust and filings from the hole. Insert rivet.

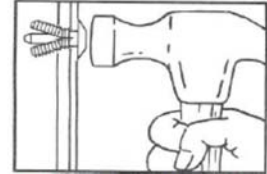

Hit the pin. The shank expands into or behind material for a tight, secure grip

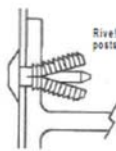

Rivet expands behind metal angles, posts, sheets, or metal studs

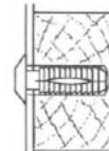

Rivet expands into hole furring strips, studs, squares of brick block, concrete, drywall

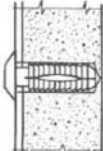

Note: If pin in rivet does not drive flush when fastening into solid materials and application where expansion may be restricted, a larger hole is required, use .261" G Bit.



Chrome pin rivet has high shear strength but should be used in low moisture areas. Installation is the same as plastic pin rivet above.

One piece-nylon rivet fastens panels to any wood substrate or wood stud. See diagram below:

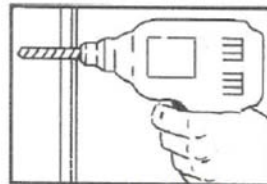

Easy to use. Drill a hole (.281"-K Bit)

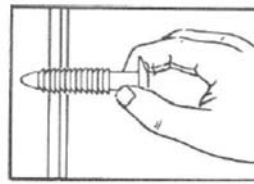

Remove dust and filings from the hole.

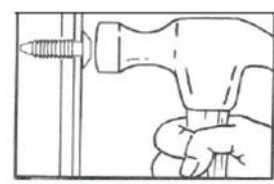

Drive rivet flush

1. FiberLite FRP panels should be adhered to a solid surface.
2. First panel installed should be set true with a plumb line. Check plumb line during installation. Do not fasten edges of panel until moldings are in place (except when using face mounted moldings.)
3. Fasten panel at center and work outward.
4. Fasteners based on 16" on center (o/c)
5. Fasteners should be staggered on opposite panel edges and next to division bar for a flat seam. See diagram below to fasten as indicated in alphabetical order.
6. FiberLite FRP panels may be pre-drilled for fasteners installation using a guide panel.

### Mechanical Fastening Pattern

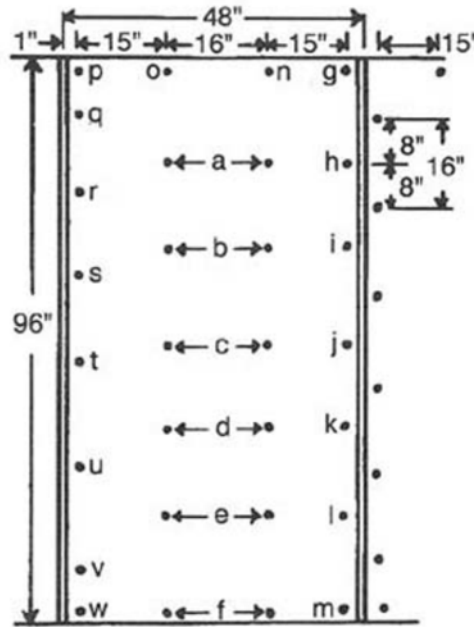

### Top View of Panel Installation

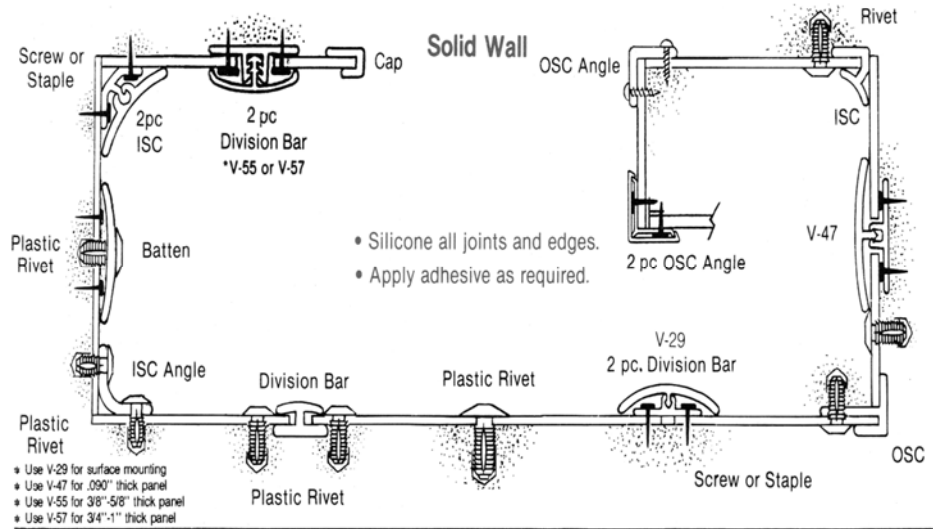

Nudo Products, Inc.  
 1500 Taylor Avenue  
 Springfield, IL 62703  
 Phone 1.800.826.4132 \* 1.217.528.5636  
 Fax 1.217.528.8722

Form 6001 Rev. 08 9/15  
[Info@nudo.com](mailto:Info@nudo.com)  
[www.nudo.com](http://www.nudo.com)

## Installation Reminders

1. Follow safety and fire guidelines during installation and use of panels. Compliance with local building codes is recommended.
2. First panel installed should be set true with plumb line. Check plumb line during installation.
3. Pre-condition panels prior to installation and allow for expansion and contraction during installation.
4. Use moldings, silicone, fasteners, and adhesive with panels for best installation.
5. Remove excess silicone during installation or trim after silicone is cured.
6. Place molding on panels, if required before fastening panels (ie. CAP, ISC, OSC, etc.).
7. Cut moldings as needed. For example, division bar may need to be cut in accommodate a ceiling or base cove.
8. Cut panels, if required, for proper installation.
9. Use hold-down clips if panels are used in a suspended ceiling.
10. Span studs or joists only with proper thickness of panel.
11. Clean panels, if required, after installation.

## Cleaning Instructions

FiberLite FRP panels are designed for minimum care and maintenance. When cleaning panels they should be washed with a light detergent. Panels may also be cleaning with steam, high pressure sprayers or soap and water.

A 5% or 10% Tri Sodium Phosphate water solutions may also be used to clean panels. Rinse thoroughly after applying. Hard water deposits may be cleaned with a 10% solution of Acetic Acid in cold water. Rinse thoroughly after applying. It is strongly recommended not to use abrasive cleaners when cleaning panels. Adhesive can be removed from panels surface by using mineral spirits or equivalent solvent based cleaners.

Note: FiberLite FRP and components made of aluminum, polystyrene foam, vinyl and wood may be combustible and accordingly should be used in compliance with local codes and insurance regulations.